



BENCHMADE®

COMMERCIAL | PROFESSIONAL
2012

BLUE CLASS pages 5-26



470 480 480-1 482 483 530 580 581 583 585 707 710 741 746

GOLD CLASS pages 3-4



940-121 4501

BALISONG® pages 21-23



4502 32 51 53 62

BLACK CLASS pages 30-61

FOLDERS pages 44-49



275 520/523/525 522/527 810 860 915 916 950

SAFETY CUTTERS pages 58-61



5 7 8 8 EOD 8 MED 9CB 30210/30200



15000 15005 15010 15015 15050 15020/15030 15040



pages 27-29



755 760 790 890 940 943 110H20 111H20 550 551 553 555 556 557



PENS pages 62-63



1100



1200



1210

FIXED BLADES

pages 50-57



118

124

164



140/141



147/148



150



158



172



175



176



375

AUTOMATICS

pages 34-47



2550



2750



3150



3300



3310



3350



3550



5000/5300/5500



5220/5270



8600



9051



9052



9101



9500



9555



13800

NEW PRODUCTS

GOLD CLASS



BLUE CLASS



BONE COLLECTOR



BLACK CLASS

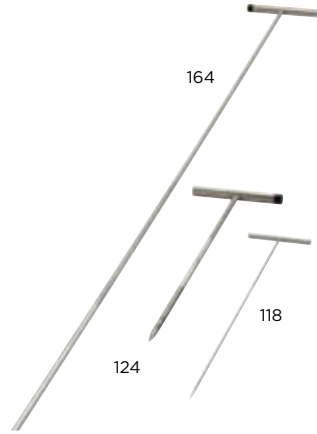

ICON LEGEND



Ambidextrous carry



Reversible carry-clip



Patented **AXIS**[®] locking mechanism



MOLLE[®] Compatible

INDEX

NSN/GSA Procurement	32-33
About Benchmade	64
Model Feature Codes	65
Designer Collaborations	66
Mechanisms	67
Materials	68
Extras	72
Clothing.....	70
Special Services.....	75
Warranty	76

GOLD CLASS

The best of the best.



OSBORNE DESIGN - U.S.A.

NEW 940-121

The classic 940 now features a CPM-M4 blade with carbon fiber and titanium handles.

- › AXIS® locking mechanism
- › Modified reverse tanto blade
- › CPM-M4 blade steel with clear Cerakote™ (62-64HRC)
- › Carbon fiber and anodized titanium handle with natural titanium backspacer, TiCN silver coated hardware and a reversible tip-up pocket clip



BLADE LENGTH	3.40" (8.64cm)
BLADE THICKNESS	0.115" (2.92mm)
OPEN	7.87" (19.99cm)
CLOSED	4.47" (11.35cm)
WEIGHT	3.41oz (96.7g)
HANDLE THICKNESS	0.41" (3.56mm)

Configurations/MSRP

940-121 \$500

The classic Prestigedges™ kitchen knives are now available with G10 handles.

- Single piece full-tang 440C stainless steel blades (58-60HRC)
- 4501: Hand finished black micarta and stabilized winewood handles with hand polished handle rivets
- 4502: Black G10 textured contoured handles



*Individual knives also sold separately.

	4501 Chef Knife	Utility Knife	Paring Knife
BLADE LENGTH	8.00" (20.32cm)	6.00" (15.24cm)	3.50" (8.89cm)
BLADE THICKNESS	0.140" (3.59mm)	0.120" (3.05mm)	0.070" (1.84mm)
OVERALL LENGTH	13.00" (33.00cm)	10.25" (26.04cm)	7.09" (18.01cm)
WEIGHT	8.50oz (241.00g)	4.80oz (136.00g)	2.10oz (60.00g)
4502			
WEIGHT	9.14oz (258g)	5.07oz (143.7g)	2.07oz (58.5g)
HANDLE THICKNESS	0.77" (19.50mm)	0.61" (15.36mm)	0.48" (12.28mm)

Configurations/MSRP

4501 (3-piece set)	\$500
4502 (3-piece set)	\$385
4535-1 (Pairing Knife)	\$110
4560-1 (Utility Knife)	\$140
4580-1 (Chef Knife)	\$180



BLUE CLASS



These spring assisted models combine speed and strength in one complete package.

- › AXIS® Assist locking mechanism
- › Multiple blade styles and sizes
- › Variety of handle materials available
- › Reversible tip-up pocket clip



581

This Barrage® gets an upgrade with G10 and aluminum handles and M390 super steel (60-62 HRC).

	580/581/583	585
BLADE LENGTH	3.60" (9.10cm)	2.91" (7.40cm)
BLADE THICKNESS	0.121" (3.07mm)	0.100" (2.54mm)
OPEN	8.35" (21.20cm)	6.91" (17.60cm)
CLOSED	4.75" (12.10cm)	4.00" (10.20cm)
WEIGHT	4.20oz (119.07g)	3.40oz (96.30g)
	581: 5.20oz (147.41g)	
HANDLE THICKNESS	0.65" (16.51mm)	0.57" (14.47mm)

Configurations/MSRP

580	\$145
580S	\$145
580BK	\$160
580SBK	\$160
581	\$225
581S	\$225
581BK	\$240
581SBK	\$240
583	\$145
583S	\$145
583BK	\$160
583SBK	\$160
585	\$135
585S	\$135
585BK	\$150
585SBK	\$150

580/583

NSN: 1095-01-598-4472 (583SBK)

The original Barrage® is now available in tanto or drop-point blade styles. These models feature a 154CM stainless steel blade (58-61HRC), Valox® handle and stainless steel liners.



580
Drop-Point

583
Tanto



585

Same powerful design in a smaller package. 154CM stainless steel blade (58-61HRC), Valox® handles and stainless steel liners.



2009
Knife of the Year

470 Emissary™

OSBORNE DESIGN — U.S.A.



This lightweight knife is an AXIS® Assist in a thin package.

- › AXIS® Assist locking mechanism with safety
- › Modified drop-point blade with ambidextrous thumb-stud opener
- › S30V premium stainless steel blade (58-60HRC)
- › CNC machined billet, high-strength aluminum alloy handles and a reversible deep carry tip-up pocket clip



BLADE LENGTH	3.00" (7.62cm)
BLADE THICKNESS	0.090" (2.28mm)
OPEN	6.90" (17.52cm)
CLOSED	3.90" (9.90cm)
WEIGHT	2.20oz (62.36g)
HANDLE THICKNESS	0.45" (11.43mm)

Configurations/MSRP

470 \$205

707 Sequel®

MCHENRY & WILLIAMS DESIGN — U.S.A.



The machined aluminum handles and black G-10 inlays provide a secure grip in any situation.

- AXIS® locking mechanism
- Modified clip-point blade with ambidextrous thumb-stud opener
- 154CM stainless steel blade (58-61HRC)
- Machined 6061-T6 aluminum handles with black G10 inlays, and a reversible tip-up reversible pocket clip



BLADE LENGTH	2.95" (7.50cm)
BLADE THICKNESS	0.100" (2.54mm)
OPEN	6.75" (17.15cm)
CLOSED	3.80" (9.67cm)
WEIGHT	2.60oz (73.70g)
HANDLE THICKNESS	0.42" (10.67mm)

Configurations/MSRP

707	\$160
707BK	\$175
707S	\$160
707SBK	\$175

741 Onslaught® 746 Mini-Onslaught®

LUM DESIGN — U.S.A.



Big or small, the Onslaught continues.

- AXIS® locking mechanism
- Modified clip-point blade with ambidextrous thumb-hole opener
- 154CM stainless steel blade (58-61HRC)
- Black G10 handle scales with a tip-up pocket clip



2010
Knife of the Year



	741	746
BLADE LENGTH	4.28" (10.87cm)	3.45" (8.76cm)
BLADE THICKNESS	0.121" (3.07mm)	0.114" (2.89mm)
OPEN	9.63" (24.46cm)	7.78" (19.76cm)
CLOSED	5.47" (13.89cm)	4.43" (11.25cm)
WEIGHT	6.96oz (197.31g)	3.90oz (110.56g)
HANDLE THICKNESS	0.65" (16.51mm)	0.63" (16.00mm)

Configurations/MSRP

741	\$190
741S	\$190
741BK	\$205
741SBK	\$205
746	\$165
746S	\$165
746BK	\$180
746SBK	\$180



Thin is in with this sub two ounce folder.

- AXIS® locking mechanism
- Modified spear-point blade with ambidextrous thumb-stud opener
- 154CM stainless steel blade (58-61HRC)
- Grivory® handle scales with a reversible tip-up pocket clip



BLADE LENGTH	3.25" (8.25cm)
BLADE THICKNESS	0.090" (2.28mm)
OPEN	7.42" (18.85cm)
CLOSED	4.17" (10.59cm)
WEIGHT	1.88oz (53.28g)
HANDLE THICKNESS	0.37" (9.39mm)

Configurations/MSRP

530	\$110
530SBK	\$125

940/943

OSBORNE DESIGN — U.S.A.



Simply designed and built for extreme performance, the machined aircraft grade aluminum handles and S30V stainless steel make these knives true workhorses.

- AXIS® locking mechanism
- 940: Modified reverse tanto blade; 943: Straight clip-point blade; ambidextrous thumb-stud opener
- S30V premium stainless steel blade (58-60HRC)
- Anodized 6061-T6 aluminum handles with stainless steel liners, color anodized titanium back spacer and a reversible tip-up pocket clip



940



943SBK

BLADE LENGTH	3.40" (8.64cm)
BLADE THICKNESS	0.115" (2.92mm)
OPEN	7.87" (19.99cm)
CLOSED	4.47" (11.35cm)
WEIGHT	2.90oz (82.21g)
HANDLE THICKNESS	0.41" (10.40mm)

Configurations/MSRP

940	\$210
940S	\$210
940BK	\$225
940SBK	\$225
943	\$210
943SBK	\$225



Our first folder to ever feature the **AXIS®** lock, the 710 is flat out a terrific piece of sports cutlery.

- **AXIS®** locking mechanism
- Modified clip-point blade with ambidextrous thumb-stud opener
- D2 tool steel blade (60-62HRC)
- Black G10 handle scales with and a reversible tip-up pocket clip



1999
Knife of the Year



BLADE LENGTH	3.90" (9.90cm)
BLADE THICKNESS	0.115" (2.92mm)
OPEN	8.80" (22.34cm)
CLOSED	4.90" (12.44cm)
WEIGHT	4.50oz (128.00g)
HANDLE THICKNESS	0.48" (12.00mm)

Configurations/MSRP

710D2	\$175
710SBKD2	\$190

These elegant knives are the perfect pocket accessories.

- › Nak-Lok® locking mechanism
- › Crowned blade spine and thumb-stud opener;
 - 480: Hollow ground S30V stainless steel utility blade (58-60HRC)
 - 480-1: Flat grind bevel M390 super steel blade (60-62HRC)
- › 480: Black G10 & stabilized wine wood handle with MIM backspacer and stainless steel black nickel-plated hardware
- › 480-1: Carbon fiber handles and nickel-plated hardware
- › 6AL-4V blue anodized titanium liners



IWA
Knife of the Year
2008



480



480-1



Sheath included

BLADE LENGTH	2.89" (7.35cm)
BLADE THICKNESS	0.09" (2.29mm)
OPEN	6.67" (16.94cm)
CLOSED	3.79" (9.63cm)
WEIGHT	1.70oz (48.19g)
	480-1: 1.80oz (51.02g)
HANDLE THICKNESS	0.37" (9.39mm)

Configurations/MSRP

480	\$205
480-1	\$225

NEW

482 Megumi™

483 Shori™

NAKAMURA DESIGN — U.S.A.

Any gentleman can appreciate these stylish, yet durable pocket knives.

- › Nak-Lok® locking mechanism
- › S30V premium stainless steel blade (58-60HRC)
- › 482: clip-point blade style
483: utility blade style
- › 482: cocobolo wood carbon fiber handle
483: contoured black G10 handle with aluminum bolster
- › MIM backspacer with lanyard hole



482



483

	482	483
BLADE LENGTH	2.48" (6.30cm)	2.85" (7.24cm)
BLADE THICKNESS	0.11" (2.63mm)	0.11" (2.63mm)
OPEN	5.76" (14.63cm)	6.60" (16.76cm)
CLOSED	3.28" (8.33cm)	3.75" (9.53cm)
WEIGHT	1.85oz (52.4g)	2.52oz (71.5g)
HANDLE THICKNESS	0.46" (11.67mm)	0.46" (11.67mm)

Configurations/MSRP

482	\$205
483	\$225

**A stout titanium monolock designed by Shane Sibert.
Overbuilt? Absolutely!**

- Titanium monolock mechanism
- Tactical drop-point blade with thumb-stud opener
- M390 super steel blade (60-62HRC)
- Titanium and G10 handles with titanium tip-down pocket clip



BLADE LENGTH	2.90" (7.37cm)
BLADE THICKNESS	0.164" (4.16mm)
OPEN	6.90" (17.52cm)
CLOSED	3.80" (9.65cm)
WEIGHT	5.50oz (156.58g)
HANDLE THICKNESS	0.61" (15.50mm)

Configurations/MSRP

755	\$245
755BK	\$260

Legendary designer Bob Lum's legacy continues with this rock-steady Ti-Monolock.

- Titanium monolock mechanism
- Tanto blade with thumb-stud opener
- CPM-M4 tool steel blade (62-64 HRC)
- Sandblasted titanium handle and tip-down pocket clip



BLADE LENGTH	4.00" (10.20cm)
BLADE THICKNESS	0.150" (3.81mm)
OPEN	9.00" (22.9cm)
CLOSED	5.00" (12.70cm)
WEIGHT	5.00oz (147.86g)
HANDLE THICKNESS	0.45" (11.43mm)

Configurations/MSRP

760BK	\$280
760SBK	\$280

Benchmade's only assisted titanium monolock is sure to fit like an extension of your own hand.

- Nitrous® Assist monolock
- Clip-point blade with thumb-stud opener
- S30V premium stainless steel blade (58-60HRC)
- Machined titanium handles with tip-down pocket clip



BLADE LENGTH	3.76" (9.55cm)
BLADE THICKNESS	0.125" (3.175mm)
OPEN	8.40" (21.33cm)
CLOSED	4.64" (11.78cm)
WEIGHT	3.80oz (112.37g)
HANDLE THICKNESS	0.41" (10.41mm)

Configurations/MSRP

790	\$250
790S	\$250
790BK	\$265
790SBK	\$265

This Nitrous® Assist allows for quick, reliable opening.

- Modified locking-liner with Nitrous® assist mechanism
- Modified drop point blade with thumb-stud opener
- 154CM stainless steel blade (58-61HRC)
- Black G10 handle scales with a deep carry tip-down pocket clip



BLADE LENGTH	3.60" (9.14cm)
BLADE THICKNESS	0.100" (2.54mm)
OPEN	8.20" (20.83cm)
CLOSED	4.60" (11.68cm)
WEIGHT	3.50oz (99.00g)
HANDLE THICKNESS	0.60" (15.24mm)

Configurations/MSRP

890	\$160
890S	\$160
890BK	\$175
890SBK	\$175

H2O Knives

BENCHMADE DESIGN — U.S.A.



Our water knives offer great corrosion resistance, cutting ability and edge retention.

- AXIS® locking mechanism on folder; Blunt tip on fixed blade
- N680 highly corrosion resistant blade steel (57-59HRC)
- 110H2O: Santoprene® handle with plastic molded sheath with single push-button lock release
- 111H2O: Modified sheepsfoot blade style with ambidextrous thumb-stud Grivory® handle scales and a reversible tip-up pocket clip



110H2O

111H2O

110H2O Fixed

BLADE LENGTH	3.43" (8.71cm)
BLADE THICKNESS	0.116" (2.94mm)
OVERALL LENGTH	7.56" (19.20cm)
WEIGHT	3.10oz (91.67g)
SHEATH WEIGHT	1.10oz (32.53g)
HANDLE THICKNESS	0.47" (11.93mm)

111H2O Folder

BLADE LENGTH	3.45" (8.76cm)
BLADE THICKNESS	0.114" (2.90mm)
OPEN	8.07" (20.32cm)
CLOSED	4.62" (11.73cm)
WEIGHT	4.90oz (139.50g)
HANDLE THICKNESS	0.522" (13.26mm)

Configurations/MSRP

110H2O-BLK	\$105
110SH2O-BLK	\$105
110H2O-YEL	\$105
110SH2O-YEL	\$105
111H2O-BLK	\$130
111SH2O-BLK	\$130
111H2O-YEL	\$130
111SH2O-YEL	\$130

NEW

62 Bali-Song®

BENCHMADE DESIGN — U.S.A.



This new Bali-song® is sure to become an instant classic.

- D2 tool steel with a crowned Weehawk blade style (60-62 HRC)
- Machined stainless steel handle
- T-latch lock
- Includes Nylon sheath



BLADE LENGTH	4.25" (10.8cm)
BLADE THICKNESS	0.127" (3.17mm)
OPEN	9.20" (23.4cm)
CLOSED	5.27" (13.4cm)
WEIGHT	6.39oz (181.15g)
SHEATH WEIGHT	0.64oz (18.0g)
HANDLE THICKNESS	0.48" (12.40mm)

Configurations/MSRP

62 \$350

51 Morpho® 32 Mini-Morpho®

BENCHMADE DESIGN — U.S.A.



These Bali-Songs® are awesome lightweight flippers.

- Patented nitrous latch locking mechanism
- D2 tool steel crowned modified spear-point blade (60-62HRC)
- Machined and skeletonized black G10 handle scales with 6AL-4V titanium blue anodized and jeweled liners
- 6AL-4V blue anodized and laser engraved titanium pocket clip



32



51

	32	51
BLADE LENGTH	3.25" (8.26cm)	4.25" (10.80cm)
BLADE THICKNESS	0.100" (2.57mm)	0.100" (2.57mm)
OPEN	7.35" (18.67cm)	9.35" (23.75cm)
CLOSED	4.39" (11.15cm)	5.40" (13.72cm)
WEIGHT	2.70oz (76.54g)	3.30oz (93.55g)
HANDLE THICKNESS	0.44" (11.25mm)	0.48" (12.20mm)

Configurations/MSRP

32	\$250
51	\$270

53 Mangus®

MARLOWE DESIGN — U.S.A.



The unique bearing system on this Bali-Song® allows for smooth handle rotation.

- D2 tool steel flat grind utility blade (60-62 HRC)
- Contoured and textured green G10 handles
- Ball bearing pivots
- Machined aluminum back space and latch
- Reversible tip-up pocket clip



BLADE LENGTH	3.15" (8.00cm)
BLADE THICKNESS	0.140" (3.56mm)
OPEN	7.82" (19.86cm)
CLOSED	4.67" (11.86cm)
WEIGHT	3.50oz (99.22g)
HANDLE THICKNESS	0.60" (15.40mm)

Configurations/MSRP

53 \$200



GRIPTILIAN®



AXIS® lock reliability, textured molded handle scales and premium blade steel make the Griptilian® the ultimate light-weight carry. All of our Griptilian® models feature the following:

- AXIS® locking mechanism with ambidextrous thumb-stud or hole opener
- 154CM stainless steel blade (58-61HRC)
- Glass-filled nylon handle material with stainless steel liners and a reversible tip-up pocket clip

	550HG/551/553	555HG/556/557
BLADE LENGTH	3.45" (8.76cm)	2.91" (7.38cm)
BLADE THICKNESS	0.115" (2.92mm)	0.100" (2.54mm)
OPEN	8.07" (20.50cm)	6.78" (17.21cm)
CLOSED	4.62" (11.73cm)	3.87" (9.82cm)
WEIGHT	3.25oz (92.13g)	2.56oz (72.57g)
HANDLE THICKNESS	0.64" (16.29mm)	0.51" (12.95mm)

THE RIGHT TOOL FOR THE RIGHT CAUSE.

A portion of the profits from the sale of this knife are donated to the OHSU Breast Cancer Institute. Available in 555HG and 556 versions.

MSRP: \$100



Benchmade is a proud supporter of the OHSU Breast Cancer Research Institute.



550HG / 555HG Griptilian®

Thumb-hole

Hollow ground modified sheepfoot blade with ambidextrous thumb-hole opener.



Configurations/MSRP

550HG	\$110	555HG	\$100	555SHG-BLU	\$100
550SHG	\$110	555HG-BLU	\$100	555SHG-YEL	\$100
550SBKHG	\$125	555HG-YEL	\$100	555SHG-PNK	\$100
550SBKHGOD	\$125	555SHG	\$100	555SHG-PNK	\$100
550SBKHGNS	\$130	555SBKHG	\$115		
550T (440C Steel)	\$90	555SBKHGOD	\$115		

551/556 Griptilian®

Thumb-stud

NSN: 5110-01-598-7727 (551SBK)

Modified drop-point blade with ambidextrous thumb-stud opener.



2002

Knife of the Year



551H20



Corrosion resistant X15 T.N blade steel (58-60HRC)

Configurations/MSRP

551	\$110	551SBK-ORG	\$125	556	\$100	556S-BLU	\$100
551S	\$110	551SBKSN	\$130	556S	\$100	556-YEL	\$100
551SBK	\$125	551H20	\$130	556SBK	\$115	556S-YEL	\$100
551SBKOD	\$125	551SH20	\$130	556SBKOD	\$115	556-PNK	\$100
551-ORG	\$110	551T (440C Steel)	\$90	556-BLU	\$100	556S-PNK	\$100
551S-ORG	\$110						

551SBK NSN 5110-01-598-7727

Tanto blade with ambidextrous thumb-stud opener.



553SBK

557

Sand



Olive Drab



Configurations/MSRP

553	\$110	557	\$100
553S	\$110	557S	\$100
553SBK	\$125	557SBK	\$115
553SBKOD	\$125	557SBKOD	\$115
553SBKSN	\$130	557SBKSN	\$120

CUSTOM GRIPTILAIN®

Choose from a variety of blade steels, handle colors, custom laser etching, and hardware. The options are endless!

To create your custom Grip and see pricing options, please visit:

www.benchmade.com/customize

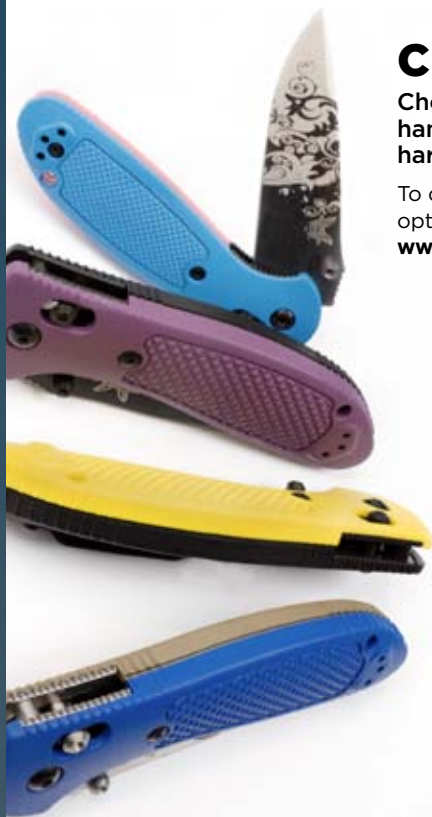

- BLACK
- OLIVE DRAB
- SAND
- ROYAL BLUE
- ORANGE
- PINK
- LIGHT BLUE
- YELLOW
- PURPLE





Michael Wassell's
**BONE
COLLECTOR™**

**BENCHMADE'S BONE COLLECTOR LINE
CELEBRATES THE CULTURE OF THE HUNTER;
THE BROTHERHOOD OF SPORTSMEN
WHO HAVE TRUE PASSION FOR THE HUNT,
THE LAND, AND THE LIFESTYLE.**



BONE COLLECTOR™ KNIVES FEATURE:

- D2 tool steel (60-62HRC)
- Contoured with rib cage pattern for extra grip.

NEW

15050 Lock Back Folding Knives

Handles are available in either green micarta or cocobolo wood; aluminum bolster.



15020



15020-2

15030-1

15020/15030 AXIS® Folding Knives

Three handle options available: black G10, layered green/black G10 or walnut.



	15020	15030	15050
BLADE LENGTH	3.36" (8.50cm)	2.95" (7.50cm)	3.73" (9.47cm)
BLADE THICKNESS	0.125" (3.14mm)	0.115" (2.87mm)	0.13" (3.27mm)
OPEN	8.20" (20.80cm)	7.08" (18.00cm)	8.48" (21.54cm)
CLOSED	4.84" (12.30cm)	4.13" (10.50cm)	4.75" (12.07cm)
WEIGHT	5.59oz (165.50g)	3.46oz (102.50g)	3.75oz (106.2g) (micarta) 3.69oz (104.7g) (wood)
HANDLE THICKNESS	0.735" (18.66mm)	0.618" (15.69mm)	0.53" (3.65mm)

15020	Black	\$155
15020S	Black	\$155
15020-1	Green/Black	\$155
15020S-1	Green/Black	\$155
15020-2	Wood	\$160
15020S-2	Wood	\$160
15030	Black	\$140
15030S	Black	\$140
15030-1	Green/Black	\$140
15030S-1	Green/Black	\$140
15030-2	Wood	\$145
15030S-2	Wood	\$145
15050	Green Micarta	\$120
15050-2	Wood	\$130

Official Licensed product of Michael Waddell's Bone Collector.™ Bone Collector is a registered trade mark of Michael Waddell LLC



Fixed Blade Knives

15000/15005/15010: Layered green/black G10 or walnut wood

15015: Micarta or cocobolo wood



GENUINE LEATHER
FIXED BLADE SHEATHS
Brown : Wood handle
Black : G10 handle
*sheath not pictured
for 15015



15040 Gut Hook

Makes cleaning game as easy as unzipping your jacket. 440C stainless steel full tang blade (58-60HRC). Nylon sheath included. **MSRP \$35**

LENGTH: 5.71" (14.50cm)

WEIGHT: 1.54oz (45.50g)

	15000	15005/15010	15015
BLADE LENGTH	4.00" (10.20cm)	4.10" (10.40cm)	2.68" (6.81cm)
BLADE THICKNESS	0.125" (3.17mm)	0.140" (3.55mm)	0.14" (3.56mm)
OVERALL LENGTH	8.00" (20.30cm)	8.125" (20.60cm)	6.30" (16.00cm)
WEIGHT	3.46oz (98.50g)	4.50oz (128.11g)	3.01oz (85.2g) (wood)
HANDLE THICKNESS	0.59" (14.98mm)	0.60" (15.23mm)	0.57" (14.70mm)

15000-1	Green/Black	\$105
15000-2	Wood	\$115
15000S-2	Wood	\$115
15000S-1	Green/Black	\$105
15005-1	Green/Black	\$120
15005S-1	Green/Black	\$120
15005-2	Wood	\$130
15005S-2	Wood	\$130
15010-1	Green/Black	\$120
15010S-1	Green/Black	\$120
15010-2	Wood	\$130
15010S-2	Wood	\$130
15015	Micarta	\$110
15015-2	Wood	\$120

This product is manufactured and distributed by Benchmade Knife Company, Oregon City, OR, USA. www.benchmade.com

BLACK CLASS

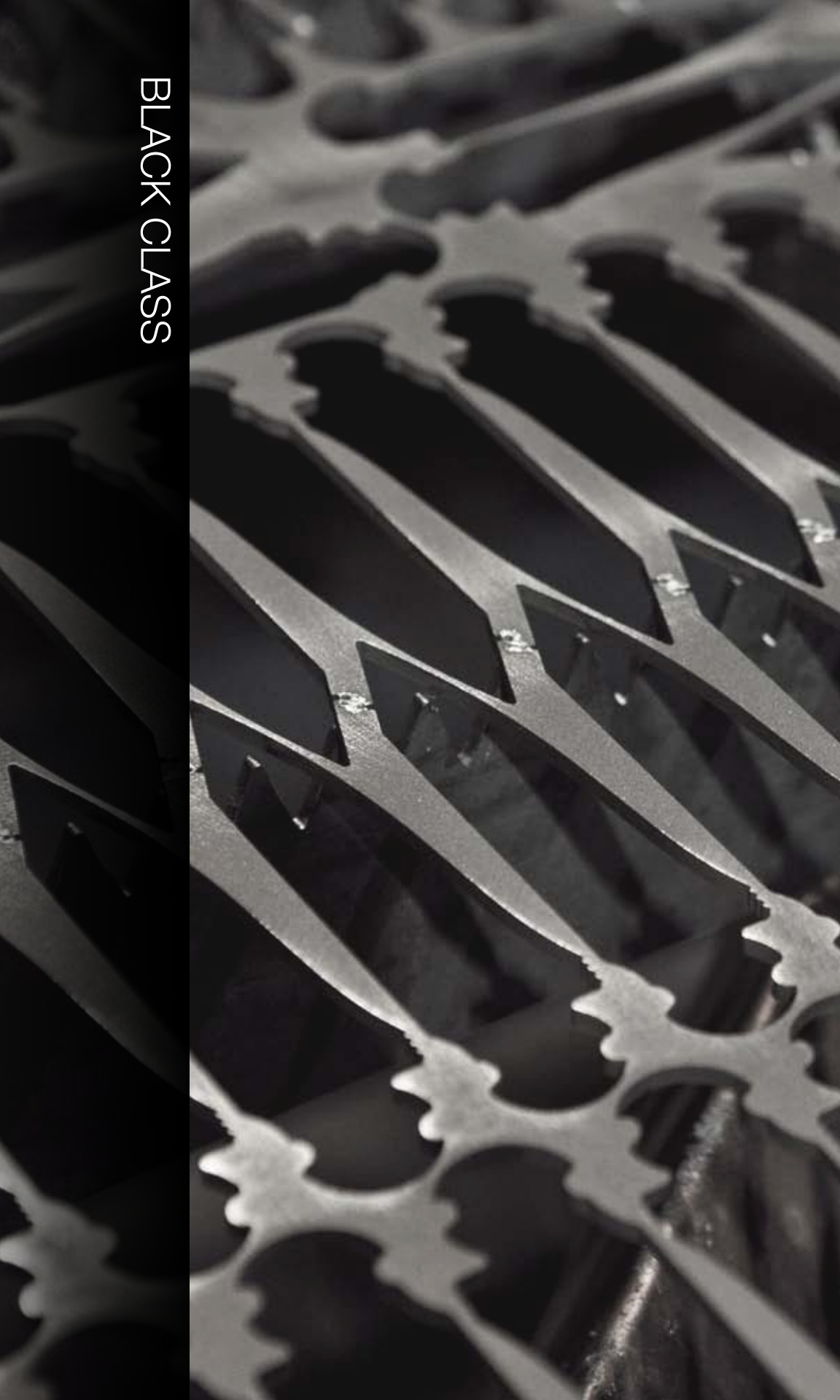



PROUD TO BE BY YOUR SIDE.

Most of us will never fully understand the responsibilities you bear, the sacrifices you make, or the risks you accept every day as part of the job you do. Without men and women brave enough, dedicated enough, and compassionate enough to heed the call to serve, what would this world be like? It is impossible to imagine.

For all you do to keep us safe and secure, you have our admiration, our support and our heart-felt thanks.

We are proud to know you carry the tools we make, and honored that, in this small way, we are by your side every day. We make it our business to ensure that when you reach for a Benchmade, it will never let you down.

OUR BLACK CLASS PRODUCTS ARE DESIGNED, DEVELOPED AND TESTED FOR EXTREME DUTY. THEY ARE THE PREFERRED CUTTING TOOLS FOR LAW ENFORCEMENT, PUBLIC SAFETY AND ELITE MILITARY TROOPS AROUND THE GLOBE.



**3350BK
MINI-INFIDEL®**
1095-01-598-4343



**3300BK
INFIDEL®**
1095-01-598-4471



**9101SBK
AUTO-STRYKER®**
1095-01-577-1801



**5000SBK
AUTO-PRESIDIO®**
4220-01-546-0478



**172BK
TOMAHAWK**
4240-01-598-4253



**140SBK
NIMRAVUS®**
1095-01-466-8569

NSN/GSA PROCUREMENT INSTRUCTIONS

- Visit our Dealer Locator at BENCHMADE.COM and enter your zip code to find your nearest dealer.
- Purchase certain Benchmade knives through the National Stocking System.
- Benchmade knives are offered by General Services Administration Federal Supply Service. Visit GSAADVANTAGE.GOV. Our contract number is: GS-07F-0537T.
- Register as a new Benchmade Public Safety customer at benchmade.com. Make sure to submit an online "Auto Knife Opening Acknowledgement" agreement if you ever plan to purchase restricted products.
- Email us at military@benchmade.com and you will be in direct contact with Benchmade's Fed/Gov Sales Department.



**916SBK
TRIAGE®**
4240-01-598-4341



**583SBK
BARRAGE®**
1095-01-598-4472



**7BLKW HOOK
PERSONAL SAFETY CUTTER**
4240-01-543-9618



**8BLKW HOOK
PERSONAL SAFETY CUTTER**
4240-01-568-3219



**8BLKWMED HOOK
PERSONAL SAFETY CUTTER**
4240-01-599-4970



**551SBK
GRIPTILIAN®**
5110-01-598-7727

NEW

MOLLE
COMPATIBLE



ADAMAS™

Latin for diamond.

Greek for “invincible” or “unconquerable.”

The Adamas™ Series of knives were designed by custom knife maker Shane Sibert to honor the courage and commitment exhibited by our fighting heroes.



275BKSN

Sheath with malice clip included

275 Manual / 2750 Automatic

- ▶ 275 Folder: AXIS® locking mechanism with thumb-stud opener
- ▶ 2750 Auto: Auto-AXIS® locking mechanism
- ▶ D2 tool steel (60-62HRC)
- ▶ Tactical drop-point blade style
- ▶ G10 handle with lanyard hole and full stainless steel liners
- ▶ Reversible, deep-carry tip-up pocket clip

Configurations/MSRP

2750BKSN	\$250
2750SBKSN	\$250
275BK	\$195
275SBK	\$195
275BKSN	\$195
275SBKSN	\$195
375SN	\$140
375BKSN	\$140
375BK	\$140
175BK	\$100
175BKSN	\$100

Rangers lead the way.

Benchmade Knife Company is proud to donate a portion of the proceeds from the sale of these knives to the Ranger Assistance Foundation. For more information, please visit benchmade.com/adamas.



375 Fixed blade

- › D2 tool steel (60-62HRC)
- › Drop-point blade style with serrations on spine
- › Injected molded sheath with secondary locking strap and tension screw



Tek-Lok included

375BKSN

175 Fixed blade



175BKSN

CORD WRAP

(paracord included)



To view video, scan code below or visit:
www.benchmade.com/375

	175	275/2750	375
BLADE LENGTH	2.50" (6.35cm)	3.82" (9.70cm)	4.20" (10.68cm)
BLADE THICKNESS	0.125" (3.175mm)	0.160" (4.06mm)	0.170" (4.32mm)
OVERALL LENGTH	5.47" (13.893cm)	8.70" (22.10cm)	9.03" (22.93cm)
CLOSED	-	4.88" (12.40cm)	-
WEIGHT	2.32oz (65.77g)	275: 7.68oz (217.50g) 2750: 7.54oz (213.60g)	5.60oz (158.75g)
HANDLE THICKNESS	0.25" (6.35mm)	0.73" (18.54mm)	0.17" (4.32mm)
SHEATH WEIGHT	1.70oz (48.19g)	1.50oz (42.52g)	1.11 oz (31.61g)





3300/3310 Infidel®

MCHENRY DESIGN — U.S.A.
NSN:1095-01-598-4471 (3300BK)

MOLLE
COMPATIBLE



The Infidel's® out-the-front mechanism is smooth and rock solid.

- Double action out-the-front auto
- Double edge spear-point or utility drop-point blade with ambidextrous thumb-slide
- 3300: D2 tool steel blade (60-62HRC)
3310: S30V premium stainless steel blade (58-60HRC)
- Black anodized, machined 6061 T-6 aluminum handle with removable deep carry pocket clip
- Integrated cleaning port



Sheath with malice clip included

	3300	3310
BLADE LENGTH	3.91" (9.93cm)	3.95" (9.93 cm)
BLADE THICKNESS	0.118" (2.99mm)	0.118" (2.99 mm)
OPEN	8.91" (22.63cm)	8.95" (22.70 cm)
CLOSED	5.00" (12.70cm)	5.00" (12.70 cm)
WEIGHT	4.90oz (138.91g)	4.90oz (128.91g)
HANDLE THICKNESS	0.59" (14.90mm)	0.59" (14.90 mm)

Configurations/MSRP

3300	\$460
3300BK	\$475
3310	\$460
3310S	\$460
3310BK	\$475
3310SBK	\$475

3300BK NSN 1095-01-598-4471



3350 Mini-Infidel®

MCHENRY DESIGN — U.S.A.
NSN:1095-01-598-4343 (3350BK)

MOLLE
COMPATIBLE



Our popular Infidel® out-the-front auto comes in a slightly smaller package.

- › Double action out-the-front auto
- › Double edge spear-point blade with ambidextrous thumb-slide
- › D2 tool steel blade (60-62HRC)
- › Black anodized, machined 6061 T-6 aluminum handle with removable deep pocket clip
- › Integrated cleaning port



Sheath with malice clip included

BLADE LENGTH	3.10" (7.87cm)
BLADE THICKNESS	0.090" (2.28mm)
OPEN	7.10" (21.35cm)
CLOSED	4.00" (10.16cm)
WEIGHT	3.40oz (100.55g)
HANDLE THICKNESS	0.54" (13.71mm)

Configurations/MSRP	
3350	\$390
3350BK	\$405

3350BK NSN 1095-01-598-4343

9051/9052 AFO II

BENCHMADE DESIGN — U.S.A

MOLLE
COMPATIBLE



The AFO II push button auto has become a proven tool used in all branches of the Armed Forces.

- Push-button automatic with integrated safety
- 9051: drop-point blade style
9052: tanto blade style
- 154CM stainless steel blade (58-61HRC)
- Black anodized, machined 6061 T-6 aluminum handle with open backspacer
- Four possible clip positions; reversible, tip-up or tip-down



9052
Tanto

9051SBK
Drop-Point

Sheath included

BLADE LENGTH	3.56" (9.0cm)
BLADE THICKNESS	0.125" (3.175mm)
OPEN	8.51" (21.6cm)
CLOSED	4.95" (12.6cm)
WEIGHT	5.8oz (164.42g)
HANDLE THICKNESS	0.60" (15.23mm)

Configurations/MSRP

9051	\$240
9051S	\$240
9051BK	\$255
9051SBK	\$255
9052	\$240
9052S	\$240
9052BK	\$255
9052SBK	\$255

9101 Auto Stryker® 9500 Mini-Auto Stryker®

BENCHMADE DESIGN — U.S.A.
NSN: 1095-01-577-1801 (9101SBK)



The 9101 next generation Auto-Stryker® incorporates a larger, stronger locking button, open back spacer design for easy maintenance and increased spring force.

- › Push-button automatic with integrated safety
- › 154CM stainless steel tanto blade (58-61HRC)
- › Machined 6061 T-6 black anodized aluminum handle
- › 9101: Four possible clip positions; reversible, tip-up or tip-down



9101BK

9500SBK

	9101	9500
BLADE LENGTH	3.60" (9.10 cm)	2.95" (7.49cm)
BLADE THICKNESS	0.124" (3.15mm)	0.100" (2.54mm)
OPEN	8.30" (21.08cm)	7.21" (18.31cm)
CLOSED	4.70" (11.94cm)	4.26" (10.82cm)
WEIGHT	4.20oz (110.56g)	2.90oz (82.21g)
HANDLE THICKNESS	0.50" (12.70mm)	0.47" (11.90mm)

Configurations/MSRP

9101BK	\$255
9101SBK	\$255
9500SBK	\$210

2550 Mini-Reflex

BENCHMADE DESIGN — U.S.A.

Test your reflexes with this small, push-button auto.

- Push-button automatic with integrated safety
- 154CM stainless steel utility drop-point blade (58-61HRC)
- Black anodized, machined 6061 T-6 aluminum handle with tip-up pocket clip



BLADE LENGTH	3.16" (8.03cm)
BLADE THICKNESS	0.100" (2.54mm)
OPEN	7.32" (18.59cm)
CLOSED	4.16" (10.57cm)
WEIGHT	2.70oz (76.54g)
HANDLE THICKNESS	0.47" (11.90mm)

Configurations/MSRP

2550	\$195
2550SBK	\$210

The spearpoint blade shape of this small auto offers enhanced tip qualities.

- Push-button automatic with integrated safety
- 154CM stainless steel spear-point blade (58-61HRC)
- Black anodized, machined 6061 T-6 aluminum handle with tip-down pocket clip



BLADE LENGTH	2.98" (7.57cm)
BLADE THICKNESS	0.090" (2.29mm)
OPEN	7.10" (18.03cm)
CLOSED	4.10" (10.41cm)
WEIGHT	2.80oz (79.38g)
HANDLE THICKNESS	0.47" (11.90mm)

Configurations/MSRP

3550	\$195
3550SBK	\$210

3150 Impel®

LERCH DESIGN — U.S.A.

The perfect small, gentleman's auto.

- Push button auto with integrated safety
- Modified drop-point blade style
- S30V premium stainless steel (58-60HRC)
- Machined aluminum handle with G10 inlay and tip-down pocket clip



BLADE LENGTH	1.98" (5.02cm)
BLADE THICKNESS	0.100" (2.54mm)
OPEN	5.03" (12.77cm)
CLOSED	3.06" (18.03cm)
WEIGHT	2.10oz (62.10g)
HANDLE THICKNESS	0.35" (8.88mm)

Configurations/MSRP

3150	\$160
3150BK	\$175

NEW

13800 Nonconformist™ 13801 Nonconformist™ Tanto



H-D® presents its first push button automatic.

- Push-button automatic with integrated safety
- 13800: drop-point blade style
13801: tanto blade style
- 154CM stainless steel blade (58-61HRC)
- Black anodized, machined 6061 T-6 aluminum handle with reversible tip-up pocket clip

HARLEY-DAVIDSON® KNIVES



Sheath included

BLADE LENGTH	3.40" (8.63cm)
BLADE THICKNESS	0.124" (3.15mm)
CLOSED	5.10" (12.95cm)
OPEN	8.50" (21.60cm)
WEIGHT	5.00oz (141.74g)
HANDLE THICKNESS	0.62" (15.74mm)

Configurations/MSRP

13800BK	\$235
13801BK	\$235
13800SBK	\$235
13801SBK	\$235



Presidio® Family

PARDUE DESIGN — U.S.A.
NSN: 4220-01-546-0478 (5000SBK)

MOLLE
COMPATIBLE



A multi-directional positive grip defines these tough, reliable folders.

- Auto features AXIS® pull release with integrated safety
- Manual features AXIS® locking mechanism and ambidextrous thumb-studs
- 154CM stainless steel blade (58-61HRC)
- Black anodized, machined 6061 T-6 aluminum handle with double 420J liners and a reversible tip-up pocket clip
- MOLLE® soft sheath (5000 & 5300 only)



Presidio Tanto
523 (Manual)
5300SBK (Automatic)

Presidio Drop-Point
5000SBK (Automatic)
520 (Manual)



Mini-Presidio
5500SBK (Automatic)
525 (Manual)



520T - Manual Trainer



5000T - Auto-Trainer



Sheath front



Sheath back
w/ malice clip

	5000/520/5300/523	5500/525
BLADE LENGTH	3.47" (8.81cm)	2.97" (7.54cm)
BLADE THICKNESS	0.125" (3.175mm)	0.115" (2.92mm)
OPEN	8.25" (20.96cm)	7.12" (18.08cm)
CLOSED	4.87" (12.37cm)	4.15" (10.54cm)
WEIGHT	5.60oz (158.76g)	3.70oz (104.89g)
HANDLE THICKNESS	0.64" (16.30mm)	0.50" (12.60mm)

Configurations/MSRP

AUTOMATIC		MANUAL	
5000	\$245	520	\$190
5000SBK	\$260	520SBK	\$205
5000T	\$155	520T	\$130
5300	\$245	523	\$190
5300SBK	\$260	523S	\$190
5500	\$220	523SBK	\$205
5500S	\$220	525	\$175
5500SBK	\$235	525S	\$175
		525SBK	\$190

5000SBK NSN 4220-01-546-0478

Presidio Ultra® Family

PARDUE DESIGN — U.S.A.



These tactical, lightweight autos deliver strength and speed in any situation.

- › Auto features AXIS® pull release with integrated safety
- › Manual features AXIS® locking mechanism and ambidextrous thumb-studs
- › 440C stainless steel drop-point blade (58-60HRC)
- › Noryl GTX® handle with reversible tip-up pocket clip



Presidio Ultra
522SBK (Manual)
522OSBK (Automatic)

Mini-Presidio Ultra
527SBK (Manual)
527OSBK (Automatic)



Benchmade is pleased to partner with USA Shooting to help in their mission of preparing American athletes to win Olympic medals and promote shooting sports throughout the U.S. A portion of the proceeds from every unit sold will be donated to the USA Shooting Team. For more info, please visit www.usashooting.org. **527BK-USA \$115** **527SBK-USA \$115**



	522/5220	527/5270
BLADE LENGTH	3.47" (8.81cm)	2.97" (7.54cm)
BLADE THICKNESS	0.125" (3.175mm)	0.115" (2.92mm)
OPEN	8.25" (20.96cm)	7.12" (18.08cm)
CLOSED	4.87" (12.37cm)	4.15" (10.54cm)
WEIGHT	4.80oz (136.07g)	3.10oz (87.88g)
HANDLE THICKNESS	0.64" (16.30mm)	0.50" (12.60mm)

Configurations/MSRP

AUTOMATIC		MANUAL	
5220	\$210	522	\$110
5220S	\$210	522S	\$110
5220BK	\$225	522BK	\$125
5220SBK	\$225	522SBK	\$125
5270	\$190	527	\$100
5270S	\$190	527S	\$100
5270BK	\$205	527BK	\$115
5270SBK	\$205	527SBK	\$115

8600 Auto Bedlam® 860 Manual Bedlam®

BENCHMADE DESIGN — U.S.A.



The scimitar-like blade on this big folder offers great functionality and a unique look and feel.

- 8600: AXIS® pull release with integrated safety
- 860: AXIS® locking mechanism and ambidextrous thumb-stud openers
- 154CM stainless steel blade (58-61HRC)
- Black G10 handle scales with reversible tip-up pocket clip



BLADE LENGTH	4.00" (10.16cm)
BLADE THICKNESS	0.125" (3.175mm)
OPEN	9.76" (24.79cm)
CLOSED	5.76" (14.64cm)
WEIGHT	7.30oz (207.83g)
HANDLE THICKNESS	0.60" (15.18mm)

Configurations/MSRP

8600BK	\$280
8600SBK	\$280
860	\$225
860S	\$225
860BK	\$240
860SBK	\$240

9555 Auto Rift® 950/950-1 Manual Rift®

OSBORNE DESIGN — U.S.A.



Reverse tanto for toughness, large-bellied blade for utility cutting, and textured G10 handle scales help you get a firm grip on any situation.

- 9555: AXIS® pull release with integrated safety
- 950/950-1: AXIS® locking mechanism with ambidextrous thumb-stud openers
- 154CM stainless steel blade (58-61HRC)
- G10 handle scales with reversible tip-up pocket clip



950-1 Manual
9555 Automatic

950
Layered Black & Grey
(Manual only)

BLADE LENGTH	3.67" (9.32cm)
BLADE THICKNESS	0.114" (2.90mm)
OPEN	8.27" (21.00cm)
CLOSED	4.60" (11.68cm)
WEIGHT	4.80oz (136.08g)
HANDLE THICKNESS	0.56" (14.28mm)

Configurations/MSRP

9555	\$245
9555S	\$245
9555BK	\$260
9555SBK	\$260
950	\$190
950SBK	\$205
950-1	\$190
950SBK-1	\$205



Latin for “protect” or “shield,” the Contego tactical folder is built with toughness and durability for any occasion.

- › AXIS® locking mechanism
- › Reverse tanto blade with ambidextrous thumb-stud openers
- › CPM-M4 steel blade with clear or black Cerakote™ (62-64HRC)
- › Textured and contoured G10 handle scales with stainless steel backspacer and reversible deep carry tip-up pocket clip
- › Carbide glass breaker



GLASSBREAKER

BLADE LENGTH	3.98" (10.11cm)
BLADE THICKNESS	0.156" (3.96mm)
OPEN	9.28" (23.57cm)
CLOSED	5.30" (13.46cm)
WEIGHT	5.92oz (167.7g)
HANDLE THICKNESS	0.55" (13.91mm)

Configurations/MSRP

810	\$210
810S	\$210
810BK	\$210
810SBK	\$210

915/916 Triage®

BENCHMADE DESIGN — U.S.A
NSN: 4240-01-598-4341 (916SBK)



This dynamic triple utility tool includes a knife, safety hook and glass breaker.

- AXIS® locking mechanism
- 915: Modified sheepsfoot blade style
916: Opposing bevel blade style
- Ambidextrous thumb-studs
- N680 highly corrosion resistant blade steel (57-59HRC)
- 440C hook-shaped safety cutter (58-60HRC)
- Textured G10 handles (available in black or safety orange) with full stainless steel liners and a reversible deep-carry pocket tip-up pocket clip
- Carbide glass breaker



2011
Knife of the Year
915 Triage®



915 SHEEPSFOOT

NEW

916SBK-ORG
OPPOSING
BEVEL



Optional Sheath - \$25

984093F Coyote
984094F Black



GLASSBREAKER

BLADE LENGTH	3.50" (8.89cm)
HOOK LENGTH	2.00" (5.08cm)
BLADE THICKNESS	0.130" (3.02mm)
OPEN	8.20" (20.82cm)
CLOSED	4.70" (11.93cm)
WEIGHT	5.10oz (144.58g)
HANDLE THICKNESS	0.53" (13.46mm)

Configurations/MSRP

915	\$170	916	\$170
915S	\$170	916S	\$170
915BK	\$185	916BK	\$185
915SBK	\$185	916SBK	\$185
915-ORG	\$170	916-ORG	\$170
915S-ORG	\$170	916S-ORG	\$170
915BK-ORG	\$185	916BK-ORG	\$185
915SBK-ORG	\$185	916SBK-ORG	\$185



140/141 Nimravus®

BENCHMADE DESIGN — U.S.A.
NSN# 1095-01-466-8569 (140SBK)

140SBK NSN 1095-01-466-8569

MOLLE
COMPATIBLE

Our all time best selling combat fixed blade.

- 140: Drop-point blade style
- 141: Modified tanto blade style
- 154CM stainless steel blade (58-61HRC)
- Full-tang, anodized machined 6061 T-6 aluminum handle
- Includes multi-function MOLLE® compatible nylon sheath



141SBK

140BK

Black

Coyote (SN)

ADC



140T Trainer

Other sheath options available separately.

	140	141
BLADE LENGTH	4.50" (11.43cm)	4.50" (11.43cm)
BLADE THICKNESS	0.115" (2.92mm)	0.115" (2.92mm)
OVERALL LENGTH	9.45" (24.00cm)	9.45" (24.00cm)
WEIGHT	6.20oz (174.95g)	5.86oz (161.13g)
HANDLE THICKNESS	0.58" (14.79mm)	0.58" (14.79mm)
SHEATH WEIGHT	5.00oz (141.75g)	5.00oz (141.75g)

Configurations/MSRP

140BK	\$180
140SBK	\$180
140SBKSN	\$195
140SBKADC	\$195
140T (440C Steel)	\$140
141BK	\$180
141SBK	\$180
141SBKSN	\$195
141SBKADC	\$195

147/148 Nim Cub II®

BENCHMADE DESIGN — U.S.A.

MOLLE
COMPATIBLE

This compact fixed blade was designed in collaboration with elite military airborne personnel.

- 147: drop-point blade style
- 148: tanto blade style
- 154CM stainless steel blade (58-61HRC)
- Noryl GTX® handle with EDM textured finish
- Includes molded MOLLE® compatible sheath



148BK
Tanto

147SBK
Drop-point

Sheath included

BLADE LENGTH	3.50" (8.9cm)
BLADE THICKNESS	0.115" (2.92mm)
OVERALL LENGTH	7.87" (20.0cm)
WEIGHT	3.20oz (90.72g)
HANDLE THICKNESS	0.59" (14.90mm)
SHEATH WEIGHT	1.10oz (31.18g)

Configurations/MSRP

147BK	\$145
147SBK	\$145
148BK	\$145
148SBK	\$145



172 Tomahawk

KILLIAN DESIGN — U.S.A.
NSN: 4240-01-598-4253 (172BK)

MOLLE
COMPATIBLE

The 1095 blade material and contoured G10 handle makes this tomahawk a very dynamic tool.

- 1095 carbon steel (52-54HRC)
- Full-tang handle with textured G10 cross-hatched pattern for ultimate grip
- Wedged end for prying
- Apple seed mill bevel for increased edge life
- Includes MOLLE® compatible nylon soft sheath with removable handle drop strap



Sheath included

HEAD LENGTH	7.50" with 3.50" edge face
SPIKE LENGTH	3.50" (8.90cm)
BLADE THICKNESS	0.360" (9.14mm)
OVERALL LENGTH	16.25" (41.27cm)
WEIGHT	36.8oz (1.04kg)
HANDLE THICKNESS	0.96" (24.38mm)
SHEATH WEIGHT	5.50oz (155.92g)

Configurations/MSRP

172BK \$350

172BK NSN 4240-01-598-4253

158 CSKII

BENCHMADE DESIGN — U.S.A.

MOLLE
COMPATIBLE

Tactile soft surfaced handle grip and thick blade construction provides added tool strength.

- › Combat/survival clip-point blade
- › Cerakote BK 1095 carbon steel blade (55-58HRC)
- › Black Santoprene® handle
- › Includes MOLLE® compatible leather sheath



Sheath included

BLADE LENGTH	6.00" (15.24cm)
BLADE THICKNESS	0.180" (4.57mm)
OVERALL LENGTH	10.75" (27.31cm)
WEIGHT	7.50oz (212.62g)
HANDLE THICKNESS	0.88" (20.29mm)
SHEATH WEIGHT	6.50oz (184.27g)

Configurations/MSRP

158BK	\$105
158SBK	\$105

150BKSN Marc Lee Glory® Knife

KILLIAN DESIGN — U.S.A.

MOLLE
COMPATIBLE

This knife honors the fearless actions and heroic behavior of Petty Officer Second Class Marc Alan Lee, the first Navy SEAL to be killed in the war in Iraq.

- 154CM stainless steel re-curve blade (58-61-HRC)
- Machined G10 handle
- Includes MOLLE® compatible multi-function nylon soft sheath

Marc Lee was part of a dedicated Naval Special Warfare team fighting the insurgency in Iraq, supporting the U.S. in its efforts to bring peace and stability to that country. His valorous conduct, exemplary leadership, and extraordinary self-sacrifice for his fellow service members have earned him the highest respect and gratitude of his fellow SEALs, the Navy, and our nation.



BLADE LENGTH	7.30" (18.5cm)
BLADE THICKNESS	0.19" (4.83mm)
OVERALL LENGTH	12.50" (31.8cm)
WEIGHT	10.10oz (286.33g)
HANDLE THICKNESS	0.75" (19.05mm)
SHEATH WEIGHT	4.80oz (136.07g)

Configurations/MSRP

150BKSN \$360

NEW 176 SOCP Dagger

THOMPSON DESIGN — U.S.A.

MOLLE
COMPATIBLE

This 176 SOCP skeletonized dagger is the optimal tool for self-defense.

- Skeletonized fixed blade dagger or trainer; feature premium blade steel
- Finger loop for ease of deployment and use
- Injection molded sheath with clip and lanyard cord



Sheath included—available in black or sand

	DAGGER	TRAINER
DAGGER LENGTH	7.25" (18.42cm)	6.81" (17.30cm)
BLADE LENGTH	3.22" (8.18cm)	2.78" (7.06cm)
HANDLE LENGTH	4.03" (10.24cm)	4.03" (10.24cm)
DAGGER THICKNESS	0.185" (4.70mm)	0.185" (4.70mm)
WEIGHT	2.20oz (62.37g)	2.31oz (65.49g)
SHEATH WEIGHT	1.00oz (28.35g)	1.00oz (28.35g)

Configurations/MSRP

176BK	\$90
(Black dagger and black sheath)	
176BK-COMBO	\$130
(Black dagger and sheath with trainer)	
176BKSN	\$90
(Black dagger and sand sheath)	
176BKSN-COMBO	\$130
(Black dagger and sand sheath with trainer)	
176T	\$60
(Trainer + sheath)	

A versatile push dagger designed for durability and strength.

- 440C stainless steel double edge spear-point with chisel ground edge (58-60HRC)
- Vinyl coated handle, full-tang
- Molded Kydex®/thermoplastic sheath with reversible belt-clip to fit up to a 2-inch duty belt (available in black or sand color)



BLADE LENGTH	2.50" (6.35cm)
BLADE THICKNESS	0.125" (3.175mm)
OVERALL LENGTH	5.47" (13.893cm)
WEIGHT	2.32oz (65.77g)
HANDLE THICKNESS	0.25" (6.35mm)
SHEATH WEIGHT	1.70oz (48.19g)

Configurations/MSRP

175BK	\$100
175BKSN	\$100

NEW

Narcotics Probes Interdiction Kit

BENCHMADE DESIGN — U.S.A.

Safely inspect suspicious packages, cargo, seat upholstery, tires and more with these high grade aluminum probes.

- › Our probes come in a variety of lengths and diameters, ranging in size from 64" for the model 164 to 18" for the models 118 and 124.
- › Each probe has a pointed, perforated tip for sample extraction and retention.
- › Threaded construction allows for easy assembly.
- › Combo kit includes 118 probe, 8 Hook safety cutter and model 916 Triage® knife.



	118	124	164
LENGTH	18.34" (46.58cm)	18.55" (47.12cm)	64.55" (163.96cm)
DIAMETER	0.188" (4.76mm)	0.375" (9.59mm)	0.375" (9.59mm)
WEIGHT	1.49oz (42.2g)	13.61oz (385.7g)	20.77oz (589g)
SHEATH WEIGHT	0.99oz (28.0g)	1.34oz (38.0g)	2.91oz (82.6g)

118	\$65
124	\$120
124/8-BLKH	\$140
124/8-COMBO (Includes 118, 916, 124, 8 Hook)	\$350
164	\$160



8BLKW NSN 4240-01-568-3219

SAFETY CUTTERS

Cut quickly and reliably in an emergency situation. All of our safety cutters are made along side our knives in the U.S.A.

- › 440C premium stainless steel used in 5, 7, 8 and 15 hooks (58-60HRC)
- › Sheath color options are black, coyote and foliage green
- › Blade opening: 0.50" (12.67mm)

MOLLE
COMPATIBLE



8 HOOK

NSN# 4240-01-568-3219 (8BLKW)

The longer handle provides greater reach and leverage.



Foliage Green



Coyote (SN)

OVERALL LENGTH	8BLKW: 6.50" (16.51cm)
WEIGHT	8BLKW: 1.50oz (42.97g)

Configurations/MSRP

8BLKW	\$35
8BLKWADC	\$35
8BLKWSN	\$35
8BLKWEOD	\$35
8BLKW MED	\$35
8BLKW MED R	\$45

*Not all available SKUs listed. Please visit our website or call customer service with inquiries.



8BLKW MED

NSN# 4240-01-599-4970 (8BLKW MED)

This hook is ideal for cutting bandages, medical tubing, casts and uniforms. O² wrench laser cut in blade. 8BLKW MEDR includes a carbide glass breaker.



8BLKWEOD

Designed to attach to robot arms for Explosive Ordnance Disposal professionals.



7 HOOK

The larger handle design works well with gloved hands and the coated handle allows for better grip.

NSN# 4240-01-543-9618 (7BLKW)

OVERALL LENGTH 4.30" (10.92cm)
WEIGHT 1.50oz (42.97g)



H20 7 Hooks feature X15-TN steel (58-60HRC) to withstand fresh and saltwater applications. Available in orange and black.

MOLLE
COMPATIBLE



5 and 7 HOOKS available in Black, Sand or Foliage Green soft sheaths.

5 HOOK

This small, compact design is great for lightweight carry.

LENGTH 2.90" (7.37cm)
WEIGHT 1.20oz (33.97g)



Black 5 hook also available. O² Wrench available in satin finish only.

Soft Sheath

Hard Sheath



#981607F

Optional lash-tab carry-clip assembly available separately for 5 HOOK.

9CB HOOK

Cuts up to 1/2" diameter rope and features a retractable safety blade cover. A carabineer clip and bottle opener complete the package.

LENGTH 5.19" (13.18cm)
WEIGHT 0.80oz (22.77g)



retractable blade cover

HOUDINI PRO®

Professional rescue tool featuring a window breaker, seatbelt cutter and LED flashlight. Made in China



30210

30200

Configurations/MSRP

7BLKW (Black Sheath)	\$35	5 (Hard Sheath)	\$35
7BLKW-ORG (Black Sheath)	\$35	5BLK (Hard Sheath)	\$35
7BLKBTL (Seatbelt mount)	\$35	5W (Soft Sheath)	\$35
7BLKBTL-ORG	\$35	5BLKW (Black Soft Sheath)	\$35
7BLKWADC (Foliage Green Sheath)	\$35	5BLKWSN (Coyote Soft Sheath)	\$35
7BLKWSN (Coyote Brown Sheath)	\$35	5BLKWADC (Foliage Green Soft Sheath)	\$35
7H20W (Orange)	\$55	9CB-BLK	\$30
7BH20W (Black)	\$55	9CB-YEL	\$30
		30200 (yellow)	\$40
		30210 (black)	\$40

Our precision crafted writing tools are proudly made in the U.S.A.

- › Ergonomic knurling patterns
- › Anodized aluminum bodies, with the addition of titanium, stainless steel or damascus in the 1100
- › Caps securely snap open or closed
- › Fisher ink cartridges - refills available at benchmade.com

1200



1210



	1100	1200	1210
PEN THICKNESS	0.50" (1.27cm)	0.39" (1.00cm)	0.58" (1.47cm)
OPEN W/OUT CAP	5.10" (12.97cm)	5.03" (13.80cm)	5.78" (14.70cm)
CLOSED W/ CAP	5.33" (13.54cm)	5.98" (15.17cm)	6.00" (15.26cm)
ALUMINUM WEIGHT	1.30oz (36.85g)	0.95oz (26.93g)	1.30oz (36.85g)
STAINLESS WEIGHT	3.20oz (90.72g)	--	--
DAMASCUS WEIGHT	3.20oz (90.72g)	--	--

1100 SERIES

ALUMINUM



1100-1 (Blue Ink)



1100-2 (Black Ink)



1101-1 (Blue Ink & Tip)
1101-2 (Black Ink & Tip)



Carbide tip breaks glass



1100-5 (Blue Ink)
1100-6 (Black Ink)



1100-7 (Blue Ink)



1100-8 (Black Ink)



1100-9 (Blue Ink)
1100-10 (Black Ink)

TITANIUM



1100-15 (Blue ink)
1100-16 (Black ink)

STAINLESS STEEL



1100-3 (Blue Ink)
1100-4 (Black Ink)

DAMASCUS



1100-13 (Blue Ink)
1100-14 (Black Ink)



Damascus pattern

Configurations

1200/1210: MSRP \$150

1200-1	Silver / Blue ink
1200-2	Silver / Black Ink
1200-3	Black / Blue Ink
1200-4	Black / Black Ink
1210-1	Silver / Blue Ink
1210-2	Silver / Black Ink
1210-3	Black / Blue Ink
1210-4	Black / Black Ink

1100

Aluminum	\$120
-Carbide tip	\$130
Titanium	\$210
Stainless steel	\$180
Damascus	\$250

THE BENCHMADE DIFFERENCE

For over two decades Benchmade has been committed to designing and manufacturing world-class sports cutlery and edged tools.

We continually strive to manufacture high quality products that will deliver superior performance and provide great value for our customers.

Whether you are using a Griptilian® as a basic cutting tool or one of our professional grade rescue hooks to perform a quick cut in an emergency situation, you can count on your Benchmade to get the job done.

IT'S NOT JUST A KNIFE...

We believe that when a customer chooses to purchase a Benchmade, they don't do so just to be different, they do so because they want the best. This mindset of innovating for improvement is alive and well throughout Benchmade. It goes into every design and comes out of every product. Admittedly, it's not the easiest way to make knives, but it's the only way we know how.

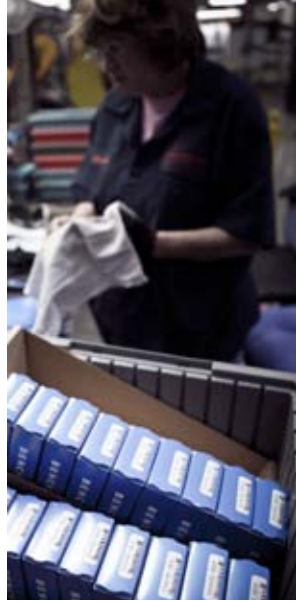

MODEL FEATURE CODES

These codes appear after the Benchmade model numbers. They identify particular feature variations within each model. (Example: Model 140SBK is a Model 140 knife which features partially serrated ComboEdge and corrosion resistant coating on the blade). We may do a limited edition of a model where the model number does not change but does get an addition to the ending, such as 940-121.

- | | | | |
|------------------|---|-------------|--------------------------------------|
| (NO CODE) | Plain edge/no blade coating | -BLU | Blue color handle |
| S | ComboEdge™ (partially serrated)/no blade coating | -YEL | Yellow color handle |
| BK | Plain edge black corrosion resistant coated blade | -ORG | Orange color handle |
| SBK | ComboEdge (partially serrated) black corrosion resistant coated blade | -BLK | Black color handle |
| OD | Olive Drab color handle | -PNK | Pink color handle |
| SN | Coyote color handle or sheath | W | Soft sheath for safety cutter |
| | | ADC | Army digital camouflage color sheath |
| | | D2 | D2 blade steel |
| | | DM | Damascus blade |
| | | CP | Clam pack |



DESIGNER COLLABORATION

Benchmade believes working with custom designers creates the most innovative and functional designs in the industry. These skilled artisans and craftsmen pour their passions into their work and agonize over every detail. By collaborating with a selection of world-class custom designers, we're able to tap into the newest locking mechanisms, modern materials, and custom blending and finishing techniques.



Mel Pardue The senior team member, Mel has been grinding sparks, making knives and creating a following for 25-plus years. His style has a class and simplicity all its own. The Pardue collaborations offer great utility to the everyday knife user while at the same time presenting an upscale distinction. Less is definitely more with Mel's designs.

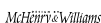

Bill McHenry & Jason Williams It runs in the family... Bill and stepson Jason spend their days making exquisite pieces of "art with an edge on it." Their dedication and talents compliment one another very well, and have led to several noteworthy innovations in the knife making world. Benchmade was fortunate to be involved with one such innovation, the AXIS[®] mechanism. The rest is history in the making.



Warren Osborne Being raised in the farming and ranching industry taught Warren early on what great utility a quality knife can offer. How a knife feels in the hand over extended use, blade design/edge configurations, and the types of materials used are all mandatory considerations of an Osborne design.



Seiichi Nakamura Engineering was his life's work until he retired to focus his efforts on a passion for custom knife work. He specializes in small Japanese style folders, gentlemen's carry and jewelry knives. His eye for artistry and mechanical engineering make him a perfect fit for the innovative Benchmade team.



Shane Sibert Since 1994, Shane Sibert's goal has been to design and create unique knives that will invoke pride of ownership, while at the same time perform tasks and challenges with exceptional ease. A life-long avid backpacker, Sibert draws inspiration from hiking throughout the Pacific Northwest's vast wilderness. He's an occasional practitioner of martial arts, and enjoys S.C.U.B.A. diving in Oregon's chilly waters.



Ken Steigerwalt In 1978 at the age of 15, Ken found himself at the kitchen table with some files and a vise. Three years later he decided that knifemaking was going to be his full time career. Since then, Ken has dedicated himself to wowing the industry with his innovative style and describes his work as a passion and a journey to build a better knife than the last. Benchmade has been fortunate to be involved with one such innovation, the Nitrous[®] Assist mechanism.



Eddie Killian Born with a love of knives, Eddie has carried a knife in his pocket since the second grade, and started to make his own knives in his garage in 2003. A volunteer Search and Rescue Team Leader, Eddie is also a Certified Technical Rigging Instructor specializing in Technical/Tactical Rope Rescue Rigging for Search and Rescue teams, Fire Agencies, Law Enforcement and Military personnel. He is the founder of Durango, CO based K5 Tactical. He works as an industrial two-way radio system designer and consultant, as well as Military and Law Enforcement equipment designer. Eddie has worked with countless local, state and federal agencies including the California Highway Patrol, U.S. Secret Service, Department of Justice, and the Department of the Treasury.



Matthew Lerch Codeveloper of the Nitrous[®] Assist mechanism, Matthew has his finger on the pulse of industry leading innovations and will continue to be a valuable contributor to Benchmade's genuine passion for that next, better design.



Bob Lum Growing up in the Pacific Northwest gave him an opportunity to develop an appreciation for the importance of a fine knife, which comes through in his elegant and utilitarian designs. Thanks, Bob.



Charles Marlowe Charles Marlowe began making knives when he was fifteen years old in his father's workshop. His passion developed throughout his college career and he has been designing knives ever since. Known for his unique butterfly knife designs, Charles and Benchmade share a mutual commitment to precision and quality.



Greg Thompson Greg Thompson is the creator of Special Operations Combatives Program (SOCP), a designated program for U.S. Army Special Operations Forces. With over twelve years of experience training Special Operations soldiers, Greg currently works as the Director of Training for the 18 ABN CORPS at Fort Bragg, NC.

LOCKING MECHANISMS

Seems simple enough. You open the knife, you close the knife. But it's the mechanics of motion that happens in the process of opening and closing which can make the difference between ordinary and extraordinary. Is the knife easy to actuate, can it be opened with one hand, is it ambidextrous, and will it be reliable when you need it most? These are all essential considerations when it comes to knife mechanics.

AXIS®

A patented Benchmade exclusive, AXIS® has been turning heads and winning fans ever since its introduction. A 100-percent ambidextrous design, AXIS® gets its function from a small, hardened steel bar which rides forward and back in a slot machined into both steel liners. The bar extends to both sides of the knife, spans the liners, and is positioned over the rear of the blade. It engages a ramped, tang portion of the knife blade when it is opened. Two omega style springs, one on each liner, give the locking bar its inertia to engage the knife tang. As a result, the tang is wedged solidly between a sizable stop pin and the AXIS® bar itself. Available in manual, assist or automatic configurations.

MODIFIED LOCKING-LINER

The basic principle is an integral locking bar within the knife liner being stress bent, enabling it to spring into position behind the rear tang of the blade when the blade is opened. The locking bar wedges against the rear of the blade, locking it open until you physically push it clear and close the blade (locking-liners are made either right or left hand specific). And with a modified locking-liner you get a patented feature which helps to enhance the lock function. The function success and function failure of a locking-liner depends greatly on how well it is made and also the quality of the materials used. With Benchmade, you get both.

MONOLOCK

The monolock mechanism is basically a locking-liner on steroids. The knife liner is one in the same as the knife handle, and thus it is designed and made to function as the locking mechanism. Subsequently, a thicker material is used to provide enough surface area to be a functional handle, and in turn creates a larger surface area to lock the blade with. If executed properly, the monolock design rates very highly in strength and function.

NAK-LOK®

Built from the framework of the locking-liner with some innovative updates. The lock engages using tensile strength, compared to the compression hold of more traditional locking-liners. With the Nak-Lok®, the possibility of personal injury is greatly reduced with the opening finger never crossing the blades path.

NITROUS®

Another patented Benchmade exclusive, the Nitrous® boosts the blade with ease. As the blade is closed the two torsion arms which run the length of the handle liners are secured in place and make contact with the blade tang. As tensioned against the blade tang, the user rotates the blade open to a 30-degree angle, the torsion arms take over and continue the blade opening process on its own. The huge advantages to the Nitrous® design over other similar concepts, is that the blade must be rotated open to beyond a 30-degree angle, which offers added user control.

AUTOMATIC

Restricted to Active Duty military, Law Enforcement and Public Safety, these are folding knives, which open at the push of a button. The blade is deployed out from the handle side like traditional folding knives, but the blade is spring open assisted to a fully locked position. The Benchmade autos take full advantage of a powerful coil spring blade actuator coupled with our precisely machined taper lock mechanism, proving itself to be the most reliable system available in auto open knives. Our patented integrated safety mechanism (located on handle spine) ensures that the blade will not inadvertently deploy or close once it is locked open.

BALI-SONG®

As much an art form as it is the ultimate example of form following function. The Bali-Song or butterfly knife is of Filipino ancestry dating back to nearly 800 A.D. Its basic form consists of a pin-hinged, two piece handle, which when closed encases the blade for carry. Opening and closing can be accomplished with a single hand, making the tool that much more utility capable.

BLADE STEELS AND FINISHES

Benchmade uses a variety of modern materials specially selected for their superior performance characteristics. We strongly believe that if you're going to put this much effort into designing a custom quality cutting tool, then it only makes sense to build it with materials that compliment its form and enhance its function.

154CM

An American-made premium grade stainless steel originally developed for tough industrial applications. Known for its best all-around qualities, it offers great corrosion resistance with good toughness and edge quality.

S30V

An American-made and developed premium grade stainless steel created especially for knives. It is a powder-made steel with a uniform carbide distribution and clean steel properties. As a blade material, it offers excellent corrosion resistance and superb edge qualities.

CPM-M4

Special purpose, high-speed steel with a combination of high Carbon, Moly, Vanadium and Tungsten for excellent wear resistance and toughness. A powder-metal, non stainless steel.

D2

An air-hardened tool steel that offers excellent wear resistance. A good choice for hard use applications.

440C

A high-chromium stainless steel with a terrific balance of good hardness and corrosion resistance. 440C takes a nice edge and is fairly easy to resharpen. An excellent value-priced steel for its performance.

M390

A high performance blade steel with superior cutting ability and wear resistance due to its high concentration of vanadium and chromium carbides. Its unique powder metallurgical process also promotes a uniform carbide distribution and clean steel properties, making M390 a popular steel used in surgical cutting instruments and in applications requiring a high finish. As a blade material it offers excellent corrosion resistance due to its high concentration of chromium.

N680

A chromium-molybdenum conventionally produced stainless steel with the addition of vanadium and nitrogen. Excellent corrosion resistance properties, especially in salt water. Good hardenability and high obtainable hardness. High wear resistance and ability to preserve keenness.

N690

An Austrian made stainless steel, which is comparable to 440C in performance and value. Keen edge qualities with great corrosion resistance.

X15-TN

This French steel was developed for the aircraft industry for jet ball bearings, as well as the medical industry for scalpels. It has the ability to resist rust in the worst of conditions while maintaining ample edge retention. The capability behind this steel is in the way it is manufactured, resulting in the finest steel for use in harsh environments such as salt water. The edge on an X-15-TN blade is easier to maintain.

DAMASCUS

A specially forged, layered steel made up of a variety of steels. It offers remarkable toughness and edge quality. For finishing, the surface layers or lines are exposed through an acid etch which creates a very unique visual effect. Used in special applications due to its inherent high cost and artistic nature.

STEEL	CARBON	CHROMIUM	COBALT	NITROGEN	MANGANESE	MOLYBDENUM	NICKEL	PHOSPHOROUS	SILICON	SULPHUR	TUNGSTEN	VANADIUM	HRC
154CM	1.05	14.00	-	-	0.50	4.00	-	-	0.30	-	-	-	58-61
S30V	1.45	14.00	-	-	0.50	2.00	-	-	0.50	-	-	4.00	58-60
X15-TN	0.40	16.00	-	-	-	2.00	-	< 0.02	-	< 0.005	-	0.35	58-60
M2	0.85	4.15	-	0.30	0.30	5.00	0.30	-	0.30	-	5.50-6.75	1.95	58-60
D2	1.50	12.00	-	0.30	0.60	1.00	0.30	-	0.60	-	-	1.00	60-62
M390	1.90	20.00	-	-	.30	1.00	-	-	.60	-	.60	4.00	60-62
N680	0.54	12.50	-	-	.40	1.10	-	-	.45	-	-	.10	57-59
N690	1.07	17.00	1.50	-	0.40	1.10	-	-	0.40	-	-	0.10	58-60
440C	1.00	17.50	-	-	0.50	0.50	-	0.04	0.30	0.03	-	-	58-60
8CR4MOV	0.75	14.50	-	-	1.00	0.20	-	0.03	1.00	0.03	-	0.20	57-58
AUS-8	0.75	14.00	-	0.49	0.50	0.10	0.49	0.04	1.00	0.03	-	0.20	58-59
1095	1.00	-	-	-	0.40	-	-	0.04	-	0.05	-	-	57-60
9CR18MOV	0.85	13.50	1.00	-	1.00	0.20	-	-	-	-	-	0.20	58-60
CPM-M4	1.42	4.0	-	-	-	5.25	-	-	-	-	5.5	4.0	62-64

CERAKOTE™

Designed and manufactured by NIC Industries, Cerakote™ has a unique ceramic structure that out-performs competitive coatings and improves performance in both laboratory and real world settings.

COMBOEDGE

It denotes our partial serration on the plain edge blade configuration. Benchmade's serration pattern offers ideal cutting ability for fibrous materials such as webbing, straps, netting, or rope.

HEAT-TREATMENT

Over the years we have developed a "special recipe" for heat-treating our blade steels. This process maximizes the steel's molecular structure for a custom toughness and Benchmade superior performance. All steels may be created equally, but that is where it stops when it comes to Benchmade.

HANDLES

CARBON FIBER

A contemporary, premium composite of thin strands of carbon tightly woven into various weave patterns, then impregnated resin, which is most commonly clear but can be color tinted. It offers great looks and is exceptionally strong for its minimal weight.

COCOBOLO

A tropical hardwood from Central America known for being hard and dense. Its coloring ranges from orange to reddish-brown.

MICARTA

Layers of linen cloths soaked in resin and pressured together. Most commonly used on more stylish knives due to its rich color finish qualities.

6061 T-6 ALUMINUM

A nonferrous metal originally developed as a premium aircraft grade aluminum, it offers a solid handle form and function at a nominal weight. Most typically color anodized.

NORYL GTX®

A modern engineered plastic offering high-strength, low flex, and lightweight properties. Molded to form.

G10

An extremely durable makeup of layers of fiberglass soaked in resin, then highly compressed and baked. Impervious to moisture or liquid and physically stable under climate change. Most commonly black, but is available in various colors too.

ZYTEL®

A lightweight glass-filled nylon engineered for strength and durability. Widely used throughout the auto industry in engine-related components. Molded to form.

KYDEX®

A mixture of acrylic and PVC which offers outstanding impact and chemical resistance as well as fire retardancy. Widely used in the auto and aerospace industry. Molded or thermo-formed.

DELIRIN®

A lightweight and durable engineered polymer with low-wear properties. Used throughout the auto industry. Molded to form.

VALOX®

A reinforced resin with excellent stiffness, strength, and dimensional stability. Molded to form.

GRIVORY®

An amorphous nylon copolymer with exceptional dimensional stability. 50% or greater glass fill.

ANODIZATION

An electrochemical process used for adding color to titanium surfaces. A combination of chemical bath and electrical voltage level generates the desired color. A similar process is used for aluminum with the addition of a chemical coloring bath.

SANTOPRENE®

A thermoplastic elastomer which is molded to specification. It offers excellent flexibility with high tear strength and fatigue resistance. Resistance to many harsh chemicals. These features contribute to improved performance in a range of tough jobs.



LINERS

6AL 4V-TITANIUM

Considered an exotic metal alloy (Titanium + 6% Aluminum + 4% Vanadium) with an excellent strength to weight ratio which offers exceptional performance in a knife. Titanium is corrosion resistant to natural elements as well as many industrial chemicals.

410SS STAINLESS STEEL

A common knife grade with low carbon, high chromium content steel which offers excellent bend toughness and wear ability. It offers excellent corrosion resistant characteristics as well. Also used in handles.

SHEATHS

BALLISTICS NYLON

A heavy duty woven nylon fabric originally developed for use in bullet proof vests and body armor. Offers great lightweight sheath durability.

LEATHER

A natural material dating back to man's earliest beginnings in the knife world. It can be easily dyed and tooled for desired visual effect. Offers traditionally accepted levels of performance and design capability.

The following are registered trademarks of their respective companies: Delrin®, E.I. du Pont de Nemours & Company; Zytel®, E.I. du Pont de Nemours & Company; Kydex®, Kleardex Company; Noryl GTX®, General Electric Company; Valox®, General Electric Company; Xylan®, Whitford Worldwide Corporation; Kraton®, Kraton Polymers Company; Santoprene®, Advanced Elastomer Systems, Grivory®, EMS-Grivory.



Blue Classic

Short Sleeve Tee, Blue
M, L, XL, 2XL \$20.00



It's Not Just a Knife

Short Sleeve Tee, Black
M, L, XL, 2XL \$20.00



Tribal Butterfly

Ladies Tank, Black
S, M, L, XL \$20.00



Slim Fit & Ladies Sizes

Tribal Band

Slimmer Fit Short Sleeve Tee, Asphalt Grey
MENS - M, L, XL, 2XL ... \$20.00
LADIES - S, M, L, XL \$20.00



Front Left Chest Back

Failure is Not an Option

Short Sleeve Tee, Black
M, L, XL, 2XL \$20.00



No Time for Maybe

Short Sleeve Tee, Sand
M, L, XL, 2XL \$20.00



Eagle Wings

Short Sleeve Tee, White
M, L, XL, 2XL \$20.00



Sting Like a Butterfly

Long Sleeve Hoodie, Black
M, L, XL, 2XL \$40.00



Full Zip Hoodie

Full Zip Hoodie, Black
S, M, L, XL, 2XL \$50.00



Back

ATTACHMENTS



Men's OGIO® jacket

- 100% poly stretch shell bonded to poly mesh with a laminated film insert for wind and water resistance
 - 3,000MM waterproof rating
 - 3,000G/M breathability rating
- S, M, L, XL, 2XL; Black\$115.00



Ladies OGIO® polyfleece

- 100% poly interlock bonded to 12-ounce, 100% poly microfleece
 - Zip-through cadet collar with rib knit detail
- XS, S, M, L, XL, 2XL; Blue.....\$75.00



Full-zip Fleece

Extra soft fleece with stylish microfiber overlays at the shoulders, sleeves and hips. Embroidered logo on left chest. Available in brown or black.

XS, S, M, L, XL, 2XL\$65.00



Benchmade pint glass

988053F\$10.00



Black Flexfit® Hat

983881F - S-M\$20.00

983798F - L-XL\$20.00

Tactical Hat

987908F; Coyote Tan\$20.00



Benchmade cooler

Can be used as a lunch tote or a cubic cooler.

988052F\$20.00



Logo Beanie

983793F - Grey\$12.00

988051F - Black.....\$12.00

EXTRAS

Folder Pouch (MOLLE® Compatible)

These snap-over hood closure pouches secure the knife well and can be used for belt carry with the Malice clip (included), and are Molle® system enabled too. Heavy stitch and elasticized fit offer a true fit. Made in USA.

- MOLLE® Folder Pouch**\$25.00
 A. 984818F – Black for models 3300 and 9051/9052
 B. 984094F – Black for models 5000 and 915
 C. 984093F – Coyote for models 5000 and 915



140/141 Fixed Sheath (MOLLE® Compatible)

Sheaths come standard with Malice clip and Velcro® adjustable belt hanger for belt carry. Heavy stitch and hard liners stow the knife securely and a snap-around closure secures the handle. Made in USA.

- MOLLE® Fixed Soft Sheath**\$50.00
 D. 983468F – Black
 E. 983854F – Foliage Green
 F. 983469F – Coyote



155/158 Fixed Sheath Kit

Based on the 140/141 soft sheaths. Built tough enough for any mission. Made in USA.

- MOLLE® Fixed Sheath**.....\$60.00
 984143F – Black
 984145F – Coyote (not shown)
 984144F – Foliage Green (not shown)



Malice® Clips

Injection molded connecting-clip to attach sheaths to Molle® systems, or to use as a belt loop style carry. Clips securely close with a snap-lock.

- 983551F – Large Malice Clip (4.75" size)\$2.00
 983550F – Small Malice Clip (3" size).....\$1.50



5hook/7hook/8hook Pouch (MOLLE® Compatible)

These Velcro® hood closure pouches secure the Rescue Hook for belt carry, and are MOLLE® system enabled with the Malice® clip (sold separately). Made in USA.

- MOLLE® 5 Hook Pouch**\$8.00
 H. 981494F – Black
 I. 983856F – Foliage Green
 J. 983855F – Coyote
- MOLLE® 8 Hook Pouch**\$12.00
 N. 985398F – Black
 985570F – Foliage Green (not shown)
 985569F – Coyote (not shown)

MOLLE® 7 Hook Pouch

-\$10.00
 K. 984166F – Black
 L. 984205F – Foliage Green
 M. 984204F – Coyote

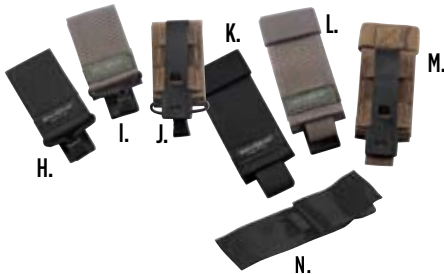

Sheath Accessories

We offer several carry accessories so you can modify your Benchmade sheaths to suit your carry needs.

(NOTE: Some items are limited to model specific applications, and individual lash tabs not pictured).

- P. 981607F – Metal-Clip w/lash tab (fits Model 5, 100, 140, 141, 145, 160, 175, 10510)\$10.00
 Q. 981608F – Molded Belt-Loop w/bridge (fits Model 100, 140, 141, 145)\$10.00
 R. 981609F – Tek-Lok®, large size\$15.00
 S. 981610F – Perma-Clips® for large Tek-Lok (set of 2).....\$4.00
 T. 981611F – Carry-Strap w/4-way lash-tab.....\$10.00
 981612F – Lash-Tab, sewn onto clothing or gear (not shown).....\$5.00

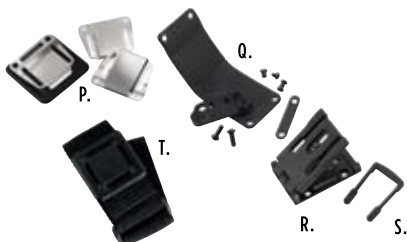

Folder Pouch/Soft Sheaths

Snap-buckle closure flap, can be worn as a belt carry, or lashed to a shoulder strap with the Velcro® lash straps. Made in China.

- U. 983170F – Folder Pouch, Black.....\$15.00

All soft sheaths are 1680 denier poly-ballistic nylon with liners and Velcro® closures. Made in USA.

- V. 981086F – Soft Sheath, Small (1.625" W x 5" D), black\$10.00
 981087F – Soft Sheath, Large (2" W x 5.25" D), black\$10.00
 981717F – Soft Sheath, 4" Bali-Song Series, black.....\$10.00



The ultimate in luxury for your Benchmade collection.

This custom blue oak chest is hand-crafted by the artisans at H. Gerstner & Sons in Dayton, OH. It's a great portable sized chest for carrying and storing your favorite Benchmades. Features include nickel plated hardware and black felt interior. Every chest is built in keeping with Gerstner's legendary tongue and groove construction. Entire case is lockable. Front lid folds up over drawers and locks for security.

Dimensions: 18" W x 12-1/2" H x 8-1/2" D

Interior capacity: 807 cu. in.

986251F \$700.00



Small Pen Case

Polyester folded folio with 10 individual pen slot areas. Zippered closures with protective padded separator. 5.5" W x 8" H
985663F - Small Pen Case \$20.00

Brag-Bag Base Shell

Tri-fold folio with 10 individual knife slot areas (6" D x 3" W). Full-width zippered flat files behind knife slots. (17.75" W x 10.50" H folded x 33" flat H)
983445F Brag-bag shell. \$60.00

Brag-Bag Pages

Folder page holds 10 individual knife slots. (16.25" W X 20" L) Fixed blade page holds 4 individual knife slots. (3.5" W x 14" L)
983446F - Brag-Bag folder page \$20.00
983447F - Brag-Bag fixed blade page \$20.00



Benchmade Knife Attaché

Soft carry-case holds 11 folders. Shell constructed of heavyweight denier with deep plush interior lining and Velcro® flap closure.
981456F - Knife Attaché \$35.00

EXTRAS



Plexiglass Knife Rack

Transparent blue plastic, holds 7 knives.
10" D x 3 3/4" W x 3" H
985567F - Knife Rack \$25.00



Metal Butterfly

Grey-blue metal butterfly perfect for display cases and other merchandising.
3 1/2" W x 3" H
981214F - Butterfly..... \$25.00



Benchmade Foam Pad

Perfect for presenting products on retail countertops.
11 5/8 x 7 3/4"
983326F - Foam Pad \$10.00



Benchmade Product Display

Sturdy, industrial-style construction with a lockable top and bottom; no assembly required.
985581F - Base \$500.00
985580F - Counter \$500.00



Blue Box

Various bit sizes with a Bit holder/extension; molded plastic case which doubles as the handle.
981084F - Blue Box \$20.00



Folding Tool Kit

Keep your Benchmade knife in tune with this 12 piece folding tool kit plus sharpener. Carry case included.
985995F - Folding Tool \$35.00



BlueLube™ BlueLube™ Cleaner

Clean, lubricate and protect your Benchmade.

983901F - BLUELUBE Cleaner (4oz bottle) \$10.00
983900F - BLUELUBE (1.25oz bottle w/ nozzle).... \$8.00

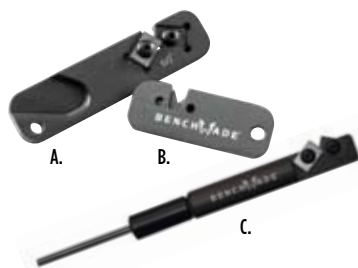

Benchmade Knife Sharpeners

A. The Tactical Pro Sharpener
Easy everyday carry with a ceramic honing surface. Length 3.00"
983902F - Tactical Pro Sharpener \$25.00

B. The Mini-Tactical Pro
Smaller version of the Tactical Pro. Length 2.00"
983903F - Mini-Tactical Pro Sharpener ... \$20.00

C. Combo Sharpener
Diamond honing rod allows you to sharpen serrated portions of the blade. Includes sheath for convenient belt-carry. Length 5.75"
985547F - Combo Edge Sharpener..... \$30.00

SPECIAL SERVICES



PERSONALIZED LASER MARKING

Make any Benchmade your Benchmade. Commemorate an event or outfit the unit. Whatever the occasion, now you can have your logo or artwork laser-etched onto any Benchmade. Depending on the particular model, the mark can be placed either on the blade, or in some models, on the handles. If you are interested in this special service, simply call a Benchmade customer service representative at 800.800.7427 or visit www.benchmade.com/lasermark.



LIFESHARP SERVICE

BENCHMADE® LIFESHARP We will gladly sharpen your Benchmade knife to a factory razor sharp edge (service does not apply to any serrated portion of the blade). Simply ship your knife to us. We will inspect the knife for any warranted repairs and “tune” the knife for optimum performance. Ship the knife to Benchmade, postage paid and insured. Please enclose your return shipping address with \$5.00 to help cover return shipping charges. www.benchmade.com/lifesharp

WARRANTY

LIMITED LIFETIME WARRANTY

Benchmade Knife Company, Inc. ("Benchmade") warrants to the original owner that this knife will be free from defects in materials and workmanship. Benchmade will, without charge, repair or replace, at Benchmade's option, any knife returned for Warranty work and found to be defective by Benchmade. The knife must be shipped by owner prepaid and insured freight, together with a description of the problem, and must be accompanied by the original bill of sale, your charge or credit card receipt or any satisfactory proof of the original date of purchase from a retail dealer. Any automatic knife returned for Warranty service from outside of Oregon must also include a copy of the owner's active police or military identification, or be returned through the authorized Benchmade dealer from whom the knife was originally purchased. NO EXCEPTIONS WILL BE MADE.

WHAT IS COVERED

This Warranty covers replacement parts and labor.

WHAT IS NOT COVERED

This Warranty does not cover normal wear, resharpening of the blade, damage caused by neglect, misuse or the failure to perform normal or necessary maintenance, disassembly of any knife by any person other than Benchmade's Warranty department, or shipping costs for returned knives.

Do not use your new knife as a screwdriver, prybar, chisel or punch. Do not throw your knife or use it for any purpose other than cutting. Do not disassemble your knife. Do not sharpen your knife on a power grinding wheel. Any of these acts will void your Warranty. **MINIMUM CHARGE TO REASSEMBLE A KNIFE WHEN THE WARRANTY HAS BEEN VOIDED IS \$20 PLUS PARTS.**

Repair or replacement as provided under this Warranty is the exclusive remedy of the consumer. Benchmade shall not be liable for any incidental, reliance, or consequential damages or breach of implied Warranty on this product, including any damage to person or property. Benchmade's liability under any circumstances is limited to the purchase price. Some states do not allow exclusion or limitation of incidental or consequential damages, so the above limitations or exclusions may not apply to you. This Warranty gives you specific legal rights, and you may also have other rights which vary from state to state.

This knife has only one use, as a cutting tool. Benchmade's knives carry no warranty except as expressly contained herein. Benchmade disclaims all warranties of merchantability and fitness for a particular purpose other than for use as a cutting tool. There are no warranties which extend beyond the description contained herein. Please review the Warranty information and proper knife care instructions provided with each knife.

ORDERING OF AUTOMATIC KNIVES

Automatic knives are available for sale in Oregon state. All orders for automatic knives must be on departmental purchase order or letterhead with wording to the effect that the knives will be used as duty items. All orders for automatic knives must be faxed or mailed. We cannot accept phone orders for automatic knives. The sales of automatic knives is Federally regulated (refer to catalog inside cover for Federal Statutes), always check permissibility within your state or locality as non-Federal personnel may be precluded from ownership or use by State laws.

NO EXCEPTIONS WILL BE MADE.

SHIPPING OF AUTOMATIC KNIVES

All AUTOMATIC knives shipped by Benchmade will be done via the following couriers, UPS, FedEx, etc. and CANNOT be shipped through the U.S. Postal Service. Also please note that all returns of automatic knives must be shipped via alternate couriers, UPS, FedEx, etc. This in accordance with the policies of the U.S. Postal Service. Thank you.

ARE ASSIST OPEN KNIVES LEGAL?

The way that the Benchmade assist opener knives are designed and built, they are not considered an automatic or switchblade under Federal interpretations. The Optimiser® and new Nitrous® assist mechanisms must be initiated with the user manually overcoming the pull of the torsion bar or, split liner systems to activate the assist function. This is done through the use manually or, physically having to engage the blade first before opening. And, as an added safety feature, the Benchmade assist openers must have their blades rotated open to an approximately 20 to 30-degree open angle BEFORE the assist engages. This eliminates the need and complication of a secondary safety mechanism.

Even though the Benchmade assist opener models are not classified as automatics or switchblades, it is still recommended that the user research and verify the legalities in their own specific areas. Knife laws and regulations are subject

to local interpretations and may change frequently.

The purchase, use and ownership of knives is subject to a wide variety of local laws and regulations. It is impossible for Benchmade Knife Company to know or interpret all of these laws. It is the responsibility of the buyer to be aware of the laws which govern them in their specific area wherever that may be. We encourage the responsible ownership and use of knives as one of mankind's oldest tools. Be smart and be safe.

Every effort is made to ensure the accuracy of the prices and information presented in this catalog. However, we reserve the right to rectify any and all errors prior to any sale transactions. This catalog is produced annually. Visit www.benchmade.com for the latest information.

Prices shown are at suggested retail (U.S. currency). Actual purchase prices may vary. All pricing and product specifications are subject to possible change without prior notice.



Benchmade is proud to be a charter member of AKTI. Get involved. Help to protect your knife freedoms. Join AKTI today!

877.752.8770 Or www.akti.org

The following are trademarks or registered trademarks of Mentor Group, L.L.C., used under license: Adamas; Axial; Benchmade (wordmark logo); ComboEdge; Conspiracy; Emisary; Epidemic; Fieldsharp; Fugitive; Hardtail; Houdini; LifeSharp; Mangus; Megumi; Mountinside; Nightshift; Nonconformist; NTK; Prestigedgeds; Pro (bullseye logo); Ridge Top; Scorch; Shori; Soldat; Swale; T-Rod; Tailout; Ti-Fender; Trask; Triage; Venom. • The following are trademarks or registered trademarks of Benchmade Knife Company, Inc.: Activator; Ally; Ambush; Aphid; Apparition; Ares; Ascender; AXIS; Backroad; Bali-Song; Bali-Song (butterfly logo); Barrage; Bedlam; Benchmade; Benchmade (butterfly logo); Benchmite; Blitz; BlueLube; Break Cut. Escape; BT2; Dejavoo; ERT-I; Gamer; Genuine AXIS Mechanics; Glory; Gravitator; Griptilian; Hell's Kitchen; InDraft; Impet; Infidel; Instigator; Kulgera; Levitator; LFTI; Mayhem; MonoChrome; Morpho; MPR; Nagara; Nak-Lok; Nimravus; NimCub II; Nitrous; Onslaught; Opportunist; Optimiser; Pika; Presidio; Presidio Ultra; Rant; Resistor; Rift; Rolling Lock; Rukus; Sequel; Shoki; Skirmish; Stryker; Subrosa; Torrent; Tumult; Venom; Vex. • NOTE: We reserve the right to make any design and/or material modifications without prior notice. • Benchmade products may be manufactured under one or more of the following patents: U.S. Patent Nos. 5,685,079 (Rolling Lock); 5,737,841 (AXIS, Auto AXIS, AXIS Assist); 5,755,035 (Liner Lock); 5,822,866 (Automatic); 6,122,829 (AXIS); 6,438,848 (Auto AXIS); 6,550,832 (Levigator); US RE 41,259 E (AXIS, Auto AXIS, AXIS Assist); 6,675,484 (Levigator); 6,732,436 (Rolling Lock); 6,789,323 (Rolling Lock); 7,278,213 (Automatic, Liner Lock); 7,293,360 (Nitrous Bali-Song, Nitrous Liner Lock, Nitrous Lockback); 7,305,768 (Monolock); 7,305,769 (Out The Front); 7,409,766 (Lockback); 7,533,466 (Sliding Taillock); 7,562,454 (Nitrous Bali-Song, Nitrous Liner Lock, Nitrous Lockback); 7,562,455 (Out The Front); 7,748,122 (AXIS Assist); 7,987,601 (NakLok); D408,705 (Sentinel Handle); D408,706 (Stryker); D409,070 (Stryker Blade); D422,476 (710 Blade); D422,477 (Sentinel, Dark Star Knife); D422,478 (Sentinel, Dark Star Handle); D422,479 (720); D422,480 (710 Handle); D422,669 (Nimravus); D422,873 (710); D422,877 (Nimravus Handle); D425,389 (Nimravus Blade); D426,132 (720 Blade); D428,789 (710 Handle); D431,991 (Ares Handle); D432,386 (Ares); D433,913 (720 Handle); D438,442 (940 Blade); D447,925 (940 Handle); D549,561 (Rescue Hook); D553,482 (Rescue Hook); Chinese Patent Nos. ZL 98813962.6 (AXIS), ZL 03106473.6 (AXIS), ZL 02815077.5 (Levigator), ZL 200680042105.7 (Nak-Lok), ZL 200680020710.4 (Auto Assist), ZL 02828500.X (Moizis Assist); French Patent Nos. 1552088 (Levigator), 1071546 (AXIS), 97452 (Stryker); German Patent Nos. 60236820.0-08 (Levigator), 1071546 / 69821034.4-08 (AXIS), M9711869.9 (Stryker), M711870.2 (Stryker); Hong Kong Patent No. HK1037344 (AXIS); Italian Patent Nos. 1552088 (Levigator), 1071546 (AXIS), 73990 (Stryker); Japanese Patent Nos. 3659990 (AXIS), 4225896; Spanish Patent No. 1552088 (Levigator); Taiwanese Patent Nos. 187158 (AXIS), 247653 (Assist). Other Patents Pending.



300 BEAVERCREEK ROAD
OREGON CITY, OR 97045

ADDRESS SERVICE REQUESTED

PRSRRT STD
US POSTAGE

PAID

OREGON CITY, OR
PERMIT NO. 25

TELEPHONE

800.800.7427
503.655.6004

CUSTOMER SERVICE FAX

503.496.1896

EMAIL

INFO@BENCHMADE.COM

WEB

BENCHMADE.COM



HARLEY-DAVIDSON[®]

KNIVES



MADCAP™

THE TWO-TONED STEEL MAKES THIS BEEFY FIXED BLADE A PERFECT COMPANION ON THE ROAD.

13420SBK MSRP: \$135

www.h-dknives.com



LONE WOLF KNIVES[®]

LANDSLIDE™

FROM THE 3D TOPO GRIP TO THE SOLID N680 DROP-POINT BLADE, EVERY DETAIL OF THIS KNIFE MAXIMIZES VERSATILITY AND OUTDOOR PERFORMANCE.

40022-100 MSRP: \$80.00

www.lonewolfknives.com

EPIDEMIC™

BLISTERING SPEED AND FUNCTIONALITY MAKE THIS DOUBLE ACTION OUT-THE-FRONT HARD TO RESIST.

14850 MSRP: \$280/\$295



www.hk-knives.com